

Product Overview

Scanner

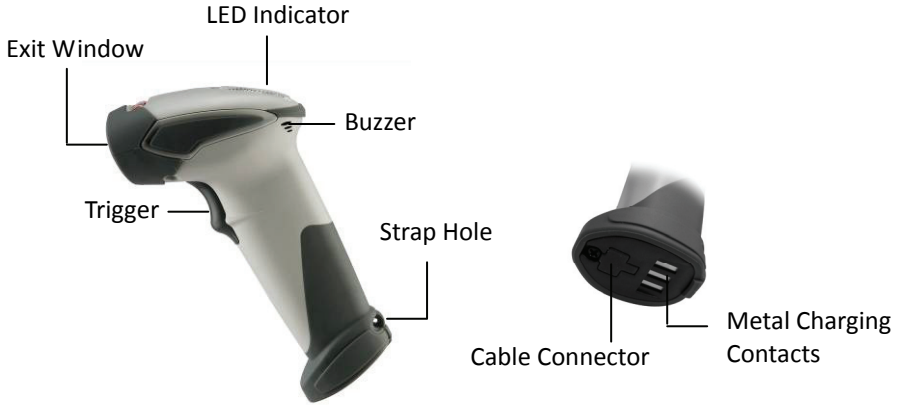

Cradle

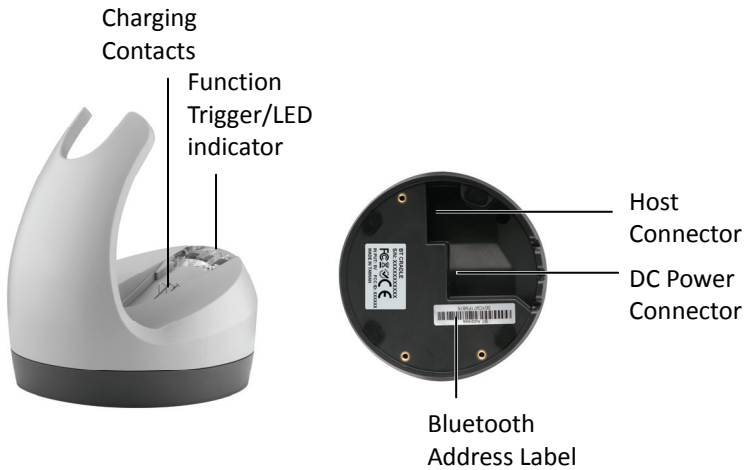

Scanner and Accessories

The scanner package contains:

Wireless scanner with battery /
Scanner cradle (optional)



(with cradle)



(without cradle)

Li-ion battery pack



Communication cable for cradle
(optional)



Mini USB B to mini USB A cable



5V USB Power adapter



CD-ROM or handbook
(Containing manual and programming guide)



Cable clip



If any contents are damaged or missing, please contact your dealer immediately.

Battery Installation

Installing Batteries

The rechargeable batteries are packed individually for shipping safety. Please follow the steps below to install the batteries.



Always use the rechargeable batteries provided by the manufacturer to avoid any non-compatible danger or void the warranty.

1. Unscrew the cap from the battery compartment at the bottom of the scanner and insert the battery.

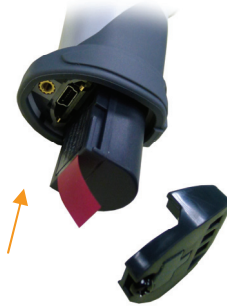

2. Make sure the red tag on the battery is tugged in and not blocking the cable connector and close the cap.



3. Tighten the screw on the cap to secure the battery.

Connecting the Cradle

The cradle host features wireless technology and is designed to support radio communication to the scanner. It can be used for both battery charging and radio communication.

1. Take the desirable interface cable and insert the RJ-45 connector on the bottom of the cradle. You will hear a clear and short “click” sound; then connect the other end to the host.
2. Connect the included USB cable to mini USB port at the bottom of the cradle and connect other end to USB power adaptor.
3. Connect the USB power adaptor into AC outlet. The LED indicator on the cradle should flash blue until it made connection with the scanner.

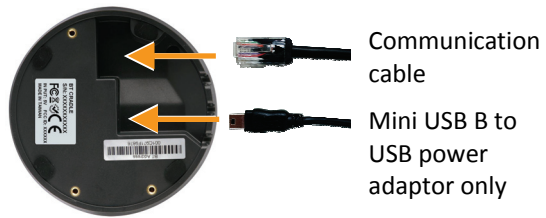

- When using Keyboard wedge and USB interface for cradle communication, it is not necessary to have an external power adapter if host has sufficient power. But these interfaces need external power adapter when charging batteries.
- The mini USB port on the bottom of the cradle should only be connected using the USB power adaptor. Please do not connect the USB cable to a PC host for charging when using the cradle.

Charging the Battery

The scanner offers two different ways to charge the battery: USB Cable or Cradle.

To charge the battery using the cradle:

1. Connect the cradle. Please see [Connecting the Cradle](#) section for more details.
2. Place the scanner on the cradle. You will hear a short beep sound from the scanner indicating scanner is in contact with the cradle.
3. The battery begins charging when the scanner LED indicator starts flashing green. LED turns steady green when charging is complete.



Approx. charging time: 4.5 hours

To charge the battery using the USB cable:

There are two method to charge scanner via USB cable.

- Host USB Power
 - Power adaptor
1. Connect the mini USB connector directly to the scanner.
 2. Connect the other end of the USB connector to the host to begin charging. You can also connect the USB cable to an outlet using the power adaptor to charge the battery.
 3. The battery begins charging when the scanner LED indicator starts flashing green. LED turns steady green when charging is complete.

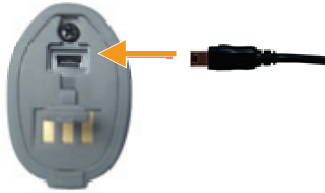

Approx. charging time: 5~6 hours



- The scanner will power on automatically when charging.
- Batteries shipped may not be fully charged and should be fully charged for maximum charge capacity.
- *Recommended* charging environment is temperature in 0°C~35°C (32°F~95°F).

Power on the Scanner

1. Ensure the battery is fully charged. Please refer to the previous section to charge the battery.
2. Press and hold the trigger for 1 second until a long beep sound is heard to turn on the scanner.

Connecting Barcode Scanner to Cradle

To pair the barcode scanner with the cradle scan the Bluetooth Address Label on the bottom of the cradle. The barcode scanner will emit three beeps:

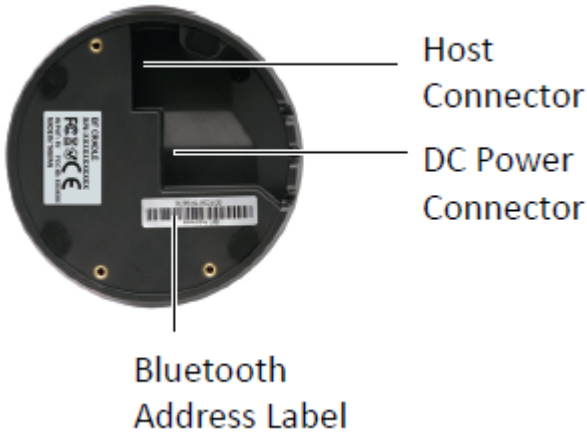

Once the barcode scanner is paired you can test the connection by opening a text editor such as Notepad. Click with Notepad and type a few characters to make sure the cursor is within notepad. Scan a barcode and make sure the barcode appears within Notepad.

How to Scan

There are two ways to scan with this device.

- Handheld scanning
- Presentation scanning

Handheld scanning

1. Power on the scanner.
2. Press the trigger and aim at the barcode as illustrated.
3. When decoding is successful, the scanner beeps and the LED indicates blue.

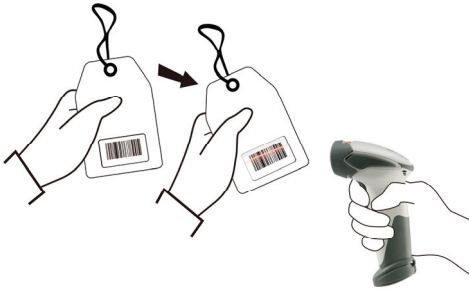

Presentation Scanning

1. Put the scanner into the cradle for presentation scanning.
2. Move the barcode label approach the scanner scanning zone.
3. When decoding is successful, the scanner beeps and the LED indicates blue.

